

Machine Handles

HAND WHEEL (DIN 388) HARD PLASTIC

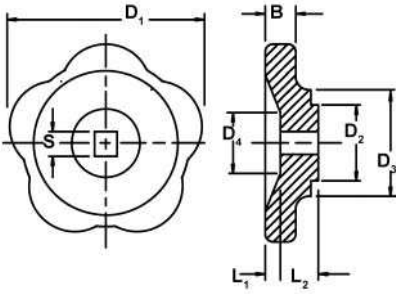

PART NO.	D ₁	S (H11)	B	D ₂	D ₃	D ₄	L ₁	L ₂
HW 6	50	6	10	22	30	22	12	6
HW 7	63	7	11	22	34	24	12	8
HW 8	80	8	12	28	38	28	14	8
HW 9	100	9	14	28	42	30	14	11
HW 10	125	10	16	34	48	32	16	12

STAR KNOB (DIN 6336) HARD PLASTIC WITH STEEL INSERT

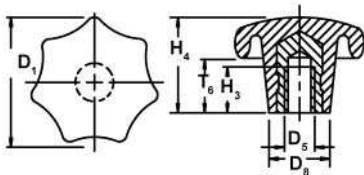

PART NO.	D ₁	D ₅	D ₆	H ₃	H ₄	T ₆
HSK M4	20	M 4	10	7	13	7.5
HSK M5	25	M 5	12	8	16	9.5
HSK M6	32	M 6	14	10	20	12
HSK M8	40	M 8	18	13	25	14
HSK M10X50	50	M 10	22	17	32	18
HSK M10X63	63	M 10	26	21	40	22
HSK M12X63	63	M 12	26	21	40	22
HSK M12X80	80	M 12	35	25	50	30

CLAMPING LEVER (DIN 99) STEEL

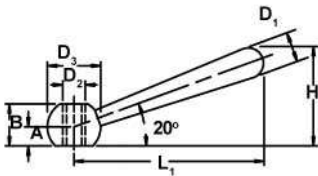

PART NO.	D ₁	D ₂	D ₃	L ₁	H	A	B
HCL M5	6	M 5	10	38	19	3	7.5
HCL M6	8	M 6	12	48	24	4	9.5
HCL M8	10	M 8	16	60	30.5	5	12.5
HCL M10	13	M 10	20	76	38	6	15
HCL M12	16	M 12	25	95	47	7.5	19
HCL M16	20	M 16	32	119	59.5	10	25
HCL M20	25	M 20	40	152	75.7	12.5	31
HCL M24	32	M 24	50	190	97	18	41

OPERATING LEVER, STEEL

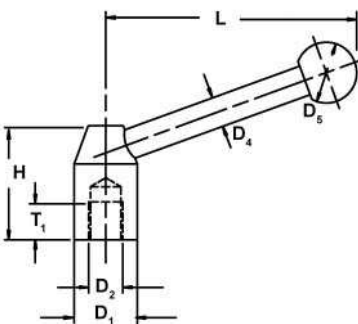

PART NO.	D ₁	D ₂	D ₄	D ₅	H	L	T ₁
HOL M8	20	M 8	8	20	33	70	15
HOL M10	22	M 10	8	20	37	82	15
HOL M12X25	25	M 12	10	25	42	96	18
HOL M12X28	28	M 12	12	30	47	110	18
HOL M16X32	32	M 16	12	32	52	124	23
HOL M16X36	36	M 16	14	35	58	138	24
HOL M20X40	40	M 20	16	40	64	152	27
HOL M20X45	45	M 20	16	40	71	170	30

Machine Handles

SOLID BALL GRIP (DIN 39) STEEL

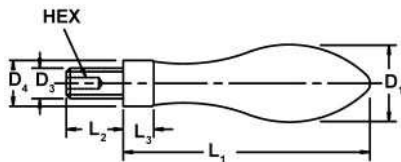

PART NO.	D ₁	D ₃	D ₄ (H13)	L ₁	L ₂	L ₃	HEX
HSBG M4 S	10	M 4	7	32	7	4	-
HSBG M5 S	13	M 5	8	40	9	5	-
HSBG M6 S	16	M 6	10	50	11	7	3
HSBG M8 S	20	M 8	13	64	13	8	4
HSBG M10 S	25	M 10	16	80	14	10	5
HSBG M12 S	32	M 12	20	100	21	13	6
HSBG M16 S	36	M 16	22	112	26	14	8

SOLID BALL GRIP (DIN 39) HARD PLASTIC WITH STEEL INSERT

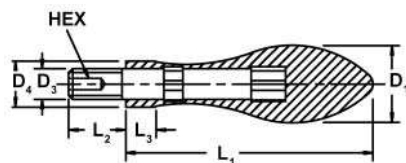

PART NO.	D ₁	D ₃	D ₄ (H13)	L ₁	L ₂	L ₃	HEX
HSBG M8 P	20	M 8	13	64	13	8	4
HSBG M10 P	25	M 10	16	80	14	10	5
HSBG M12 P	32	M 12	20	100	21	13	6

SOLID BALL GRIP (DIN 39) ALUMINUM

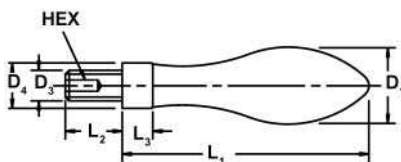

PART NO.	D ₁	D ₃	D ₄ (H13)	L ₁	L ₂	L ₃	HEX
HSBG M6 A	16	M 6	10	50	13	7	3
HSBG M8 A	20	M 8	13	64	16	8	4
HSBG M10 A	25	M 10	16	80	20	12	5
HSBG M12 A	32	M 12	20	100	25	16	6
HSBG M16 A	36	M 16	22	112	28	16	8

ROTATING BALL GRIP (DIN 98) STEEL

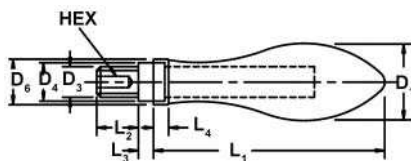

PART NO.	D ₁	D ₃	D ₄ (H13)	D ₆	L ₁	L ₂	L ₃	L ₄	HEX
HRBG M6 S	16	M 6	10	14	49	11	5.5	5	3
HRBG M8 S	20	M 8	13	18	61	13	6	6	4
HRBG M10 S	25	M 10	16	21	75	14	8	6.5	5
HRBG M12 S	32	M 12	20	26	95	21	10.5	8	6
HRBG M16 S	36	M 16	22	29	106	26	11	9	8

ROTATING BALL GRIP (DIN 98) HARD PLASTIC \ STEEL INSERT

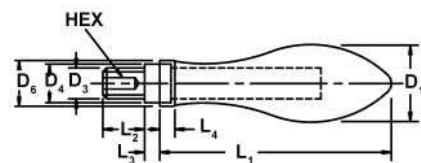

PART NO.	D ₁	D ₃	D ₄ (H13)	D ₆	L ₁	L ₂	L ₃	L ₄	HEX
HRBG M6 P	16	M 6	10	14	49	11	5.5	5	3
HRBG M8 P	20	M 8	13	18	61	13	6	6	4
HRBG M10 P	25	M 10	16	21	75	14	8	6.5	5
HRBG M12 P	32	M 12	20	26	95	21	10.5	8	6
HRBG M16 P	36	M 16	22	29	106	26	11	9	8

Machine Handles

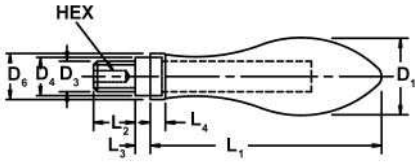

ROTATING BALL GRIP (DIN 98) ALUMINUM

PART NO.	D ₁	D ₃	D ₄ (H13)	D ₅	L ₁	L ₂	L ₃	L ₄	HEX
HRBG M6 A	16	M 6	10	14	49	11	5.5	5	3
HRBG M8 A	20	M 8	13	18	61	13	6	6	4
HRBG M10 A	25	M 10	16	21	75	14	8	6.5	5
HRBG M12 A	32	M 12	20	26	95	21	10.5	8	6
HRBG M16 A	36	M 16	22	29	106	26	11	9	8

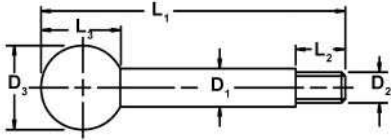

BALL LEVER, STEEL WITH HARD PLASTIC KNOB

PART NO.	D ₁	D ₂	D ₃	L ₁	L ₂	L ₃
HBL M6	8	M 6	20	89	9	18
HBL M8	10	M 8	25	111	11	22.5
HBL M10	12	M 10	32	139	14	29
HBL M12	14	M 12	35	176	16	32.5

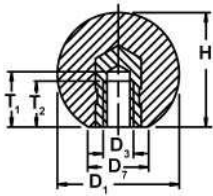

BALL KNOB (DIN 319) HARD PLASTIC WITH STEEL INSERT

PART NO.	D ₁	D ₃	H	D ₇	T ₁	T ₂
HBK M4	16	M4	15	8	7.2	6
HBK M5	20	M5	18	12	9.1	7.5
HBK M6	25	M 6	22.5	15	11	9
HBK M8	32	M 8	29	18	14.5	12
HBK M10	40	M 10	37	22	18	15
HBK M12	50	M 12	46	27	21	18

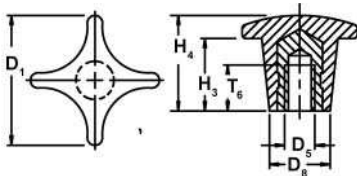

CROSS KNOB (DIN 6335) HARD PLASTIC WITH STEEL INSERT

PART NO.	D ₁	D ₅	D ₈	H ₃	H ₄	T ₆
HCK M4	20	M4	10	6	13	7.5
HCK M5	25	M5	12	8	16	9.5
HCK M6	32	M 6	14	10	20	12
HCK M8	40	M 8	18	13	25	14
HCK M10	50	M 10	22	20	32	18
HCK M12	63	M 12	26	25	40	22
HCK M16	80	M 16	35	30	50	30

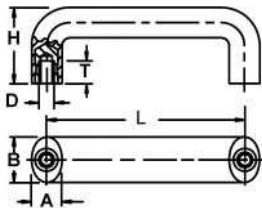

BAR HANDLE, HARD PLASTIC WITH STEEL INSERT

PART NO.	L ±0.5	A	B	D	H	T
HBH M6	86	17	26	M 6	43	12
HBH M8X117	117	20	30	M 8	54	13
HBH M8X179	179	20	30	M 8	62	13